

RECOMMENDED PC BOARD LAYOUT
WITHOUT MOUNTING POSTS

MATERIAL & FINISH

- ① CENTER CONTACT : PHOSPHOR BRONZE, GOLD PLATING
- ② BODY : ZINC ALLOY, NICKEL PLATING
- ③ INSULATOR : TPX

Note:
Tolerances:
X. ±0.5
X.X ±0.3
X.XX ±0.2

YEAR ROUND TECHNOLOGY CORPORATION TEL: 886 2 22901234 www.yr.com.tw		Title			
		50 OHM BNC COMMERCIAL VERTICAL PCB MOUNT JACK			
P/N		5BV-46	Checked By	Drawn By	Approved By
D/N		5BV-46,R			
SCALE	2:1	REV			
		UNIT	MM		

Revised dimensions and description

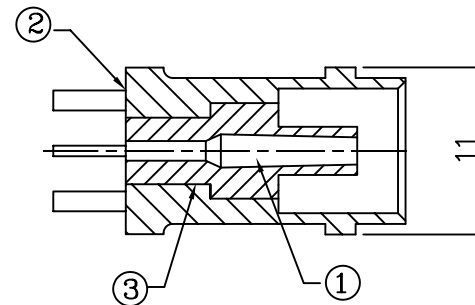
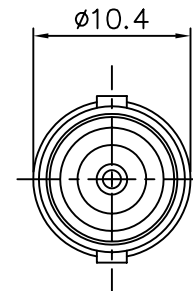
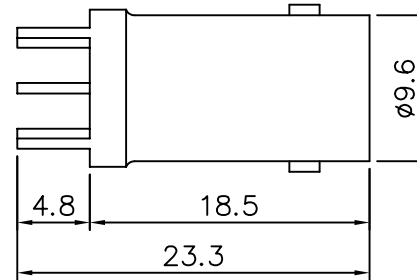
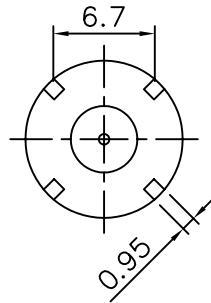
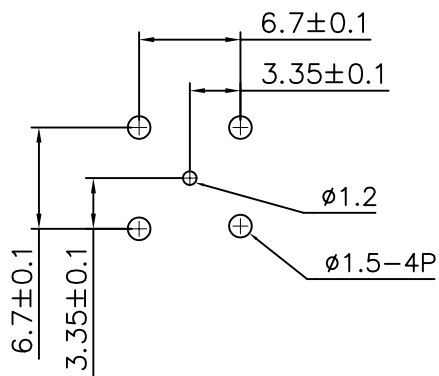

**RECOMMENDED PC BOARD LAYOUT
WITHOUT MOUNTING POSTS**

MATERIAL & FINISH





- ① CENTER CONTACT : PHOSPHOR BRONZE, GOLD PLATING
- ② BODY : ZINC ALLOY, NICKEL PLATING
- ③ INSULATOR : TPX



YEAR ROUND TECHNOLOGY CORPORATION

TEL: 886 2 22901234

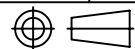
www.yr.com.tw

Title	75 OHM BNC COMMERCIAL VERTICAL PCB MOUNT JACK			
P/N	7BV-46	Checked By	Drawn By	Approved By
D/N	7BV-46,R	 柯 宏融 93,06,08	 趙 龍鴻 93,06,08	 白 添發 93,06,08
SCALE	2:1			
 		UNIT	MM	

Note:
Tolerances:
X. ±0.5
X.X ±0.3
X.XX±0.2

Revised dimensions and description